

产品规格书

Specification of products

产品名称:肖特基二极管

产品型号:MBK400U2K1

浙江世菱半导体有限公司
ZHEJIANG SHILING SEMICONDUCTOR CO., LTD.

地址:浙江省 丽水市 莲都区

电话:(0578) 3012571 3615078

传真:(0578) 3611180

邮编: 323000

E-mail:smrshiling01@163.com

Http://www.smrshiling.com

拟制	审核	核准
林益龙	曹剑龙	宗瑞

PRODUCT FEATURES

- Ultrafast Reverse Recovery Time
- Soft Reverse Recovery Characteristics
- Low Reverse Recovery Loss
- Low Forward Voltage
- High Surge Current Capability
- Low Inductance Package



APPLICATIONS

- Inversion Welder
- Uninterruptible Power Supply (UPS)
- Plating Power Supply
- Ultrasonic Cleaner and Welder
- Converter & Chopper
- Power Factor Correction (PFC) Circuit

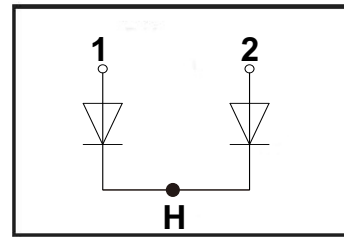

ABSOLUTE MAXIMUM RATINGS

$T_c=25^{\circ}\text{C}$ unless otherwise specified

Symbol	Parameter	Test Conditions	Values	Unit
V_R	Maximum D.C. Reverse Voltage		200	V
V_{RRM}	Maximum Repetitive Reverse Voltage		200	V
$I_{F(AV)}$	Average Forward Current	$T_c=100^{\circ}\text{C}$, Per Diode	200	A
		$T_c=100^{\circ}\text{C}$, Per Moudle	400	A
$I_{F(RMS)}$	RMS Forward Current	$T_c=100^{\circ}\text{C}$, Per Diode	280	A
I_{FSM}	Non-Repetitive Surge Forward Current	1/2 Cycle, 60Hz, Sine	4000	A
I^2t	I^2t (For Fusing)	$T_J=45^{\circ}\text{C}$, $t=8.3\text{ms}$, 60Hz, Sine	14500	A^2s
P_D	Power Dissipation		225	W
T_J	Junction Temperature		-40 to +150	$^{\circ}\text{C}$
T_{STG}	Storage Temperature Range		-40 to +125	$^{\circ}\text{C}$
Torque	Module-to-Sink	Recommended (M6)	3~4.7	N.m
Torque	Module Electrodes	Recommended (M6)	3~4.7	N.m
$R_{\theta JC}$	Thermal Resistance	Junction-to-Case	0.12	$^{\circ}\text{C}/\text{W}$
Weight			70	g

ELECTRICAL CHARACTERISTICS

$T_C=25^{\circ}\text{C}$ unless otherwise specified

Symbol	Parameter	Test Conditions	Min.	Typ.	Max.	Unit
I_{RM}	Reverse Leakage Current	$V_R=200\text{V}$	--	--	0.5	mA
		$V_R=200\text{V}, T_J=125^{\circ}\text{C}$	--	--	2	mA
V_F	Forward Voltage	$I_F=200\text{A}$	0.80	0.85	0.90	V
		$I_F=200\text{A}, T_J=125^{\circ}\text{C}$	--	0.75	--	V

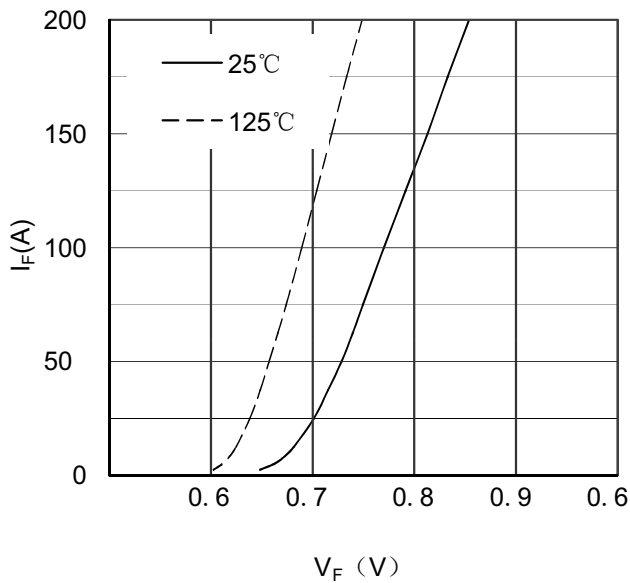

Figure 1. Forward Voltage Drop vs Forward Current

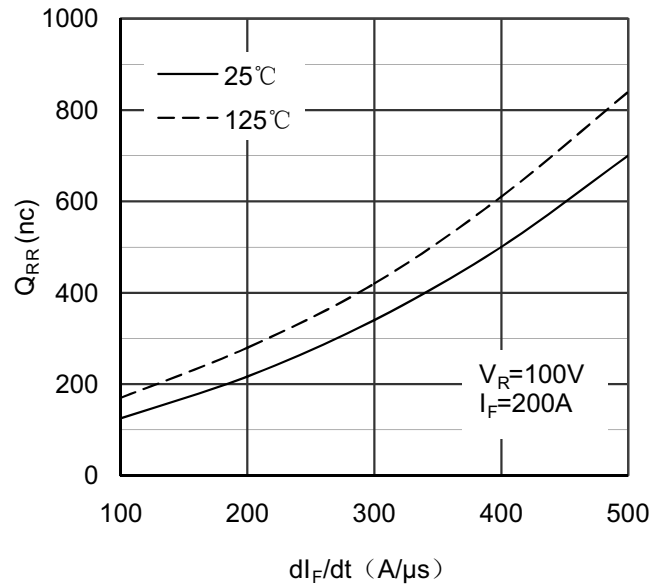

Figure 2. Reverse Recovery Charge vs di_F/dt

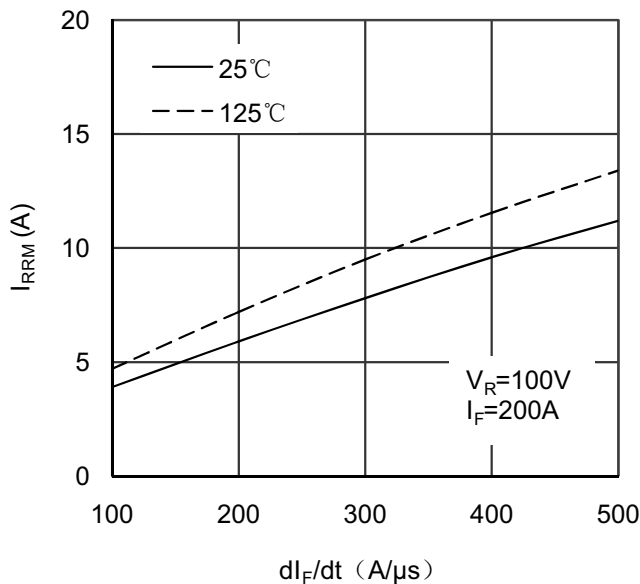

Figure 3. Reverse Recovery Current vs di_F/dt

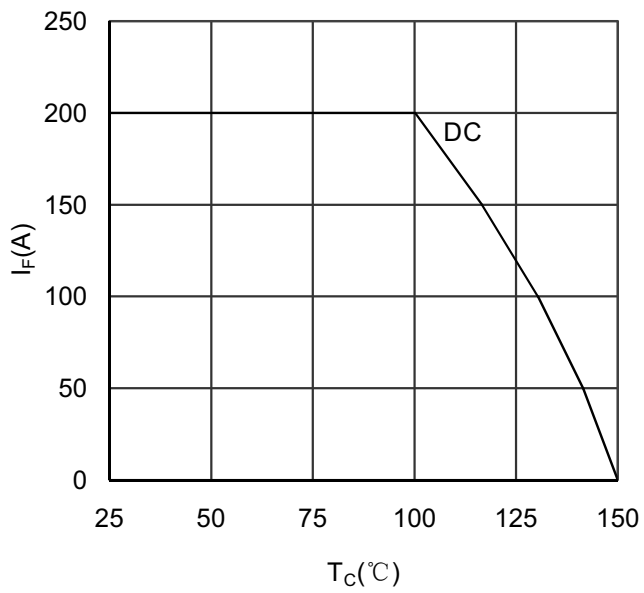

Figure 4. Forward current vs Case temperature

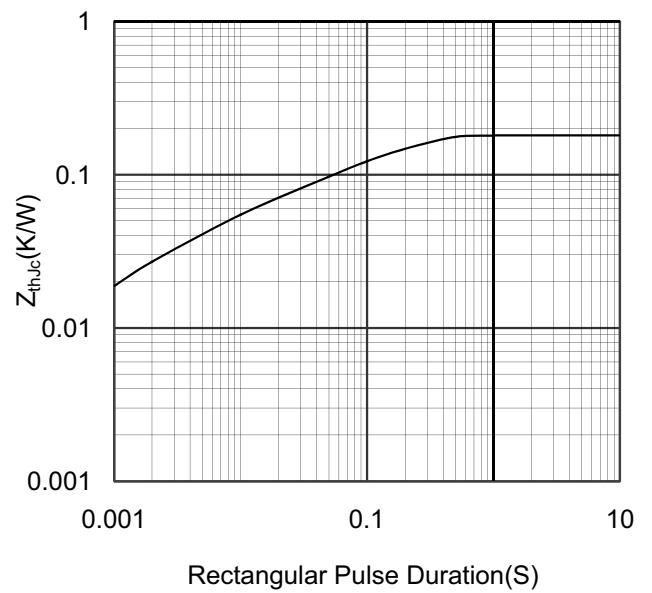
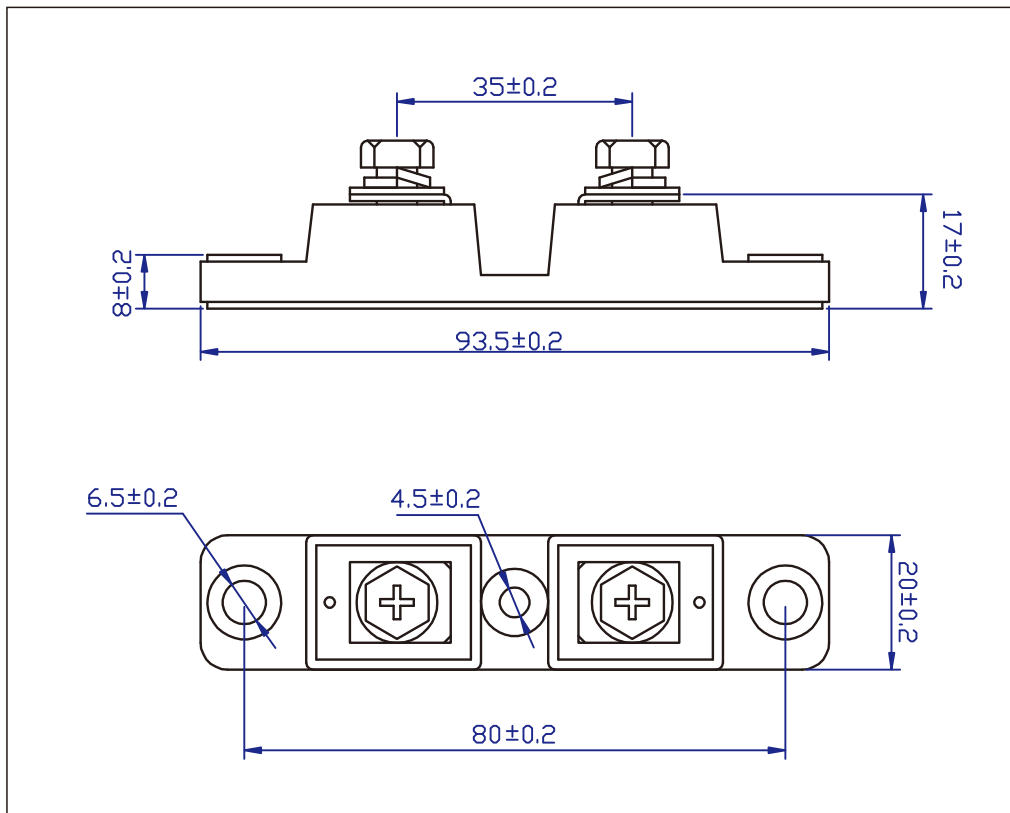

Figure 5. Transient Thermal Impedance

Package Outline



Dimensions (mm)