

产品规格书

Specification of products

产品名称:肖特基二极管

产品型号: MB2X160U1NK5

浙江世菱半导体有限公司
ZHEJIANG SHILING SEMICONDUCTOR CO., LTD.

地址: 浙江省 丽水市 莲都区

电话: (0578) 3012571 3615078

传真: (0578) 3611180

邮编: 323000

E-mail: smrshiling01@163.com

Http://www.smrshiling.com

拟制	审核	核准
林益龙	曹剑龙	宗瑞

PRODUCT FEATURES

- Ultrafast Reverse Recovery Time
- Soft Reverse Recovery Characteristics
- Low Reverse Recovery Loss
- High System Power Density
- Popular SOT-227 Package



APPLICATIONS

- Inversion Welder
- Uninterruptible Power Supply (UPS)
- Plating Power Supply
- Ultrasonic Cleaner and Welder
- Converter & Chopper
- Power Factor Correction (PFC) Circuit

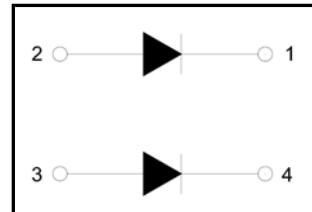

ABSOLUTE MAXIMUM RATINGS

$T_C=25^{\circ}\text{C}$ unless otherwise specified

Symbol	Parameter	Test Conditions	Values	Unit
V_R	Maximum D.C. Reverse Voltage		100	V
V_{RRM}	Maximum Repetitive Reverse Voltage		100	V
$I_{F(AV)}$	Average Forward Current	$T_C=90^{\circ}\text{C}$, Per Diode	160	A
		$T_C=90^{\circ}\text{C}$, Per Mouldle	320	A
		$T_C=100^{\circ}\text{C}$, 20KHz, Per Mouldle	200	A
$I_{F(RMS)}$	RMS Forward Current	$T_C=90^{\circ}\text{C}$, Per Diode	200	A
I_{FSM}	Non-Repetitive Surge Forward Current	1/2 Cycle, 50Hz, Sine	1700	A
		1/2 Cycle, 60Hz, Sine	1900	A
I^2t	I^2t (For Fusing)	$T_J=45^{\circ}\text{C}$, $t=10\text{ms}$, 50Hz, Sine	12960	A^2s
		$T_J=45^{\circ}\text{C}$, $t=8.3\text{ms}$, 60Hz, Sine	16400	A^2s
P_D	Power Dissipation		625	W
T_J	Junction Temperature		-40 to +150	$^{\circ}\text{C}$
T_{STG}	Storage Temperature Range		-40 to +125	$^{\circ}\text{C}$
V_{isol}	Insulation Test Voltage	AC, $t=1\text{min}$	3000	V
Torque	To-Sink	Recommended (M4)	0.7~1.1	N.m
Torque	To-Terminal	Recommended (M4)	0.7~1.1	N.m
$R_{\theta C}$	Thermal Resistance	Junction-to-Case	0.30	$^{\circ}\text{C} / \text{W}$
Weight			26.5	g

ELECTRICAL CHARACTERISTICS

$T_C=25^{\circ}\text{C}$ unless otherwise specified

Symbol	Parameter	Test Conditions	Min.	Typ.	Max.	Unit
I_{RM}	Reverse Leakage Current	$V_R=100\text{V}$	--	--	0.5	mA
		$V_R=100\text{V}, T_J=125^{\circ}\text{C}$	--	--	2	mA
V_F	Forward Voltage	$I_F=160\text{A}$	--	1.0	--	V
		$I_F=160\text{A}, T_J=125^{\circ}\text{C}$	--	0.85	--	V
t_{rr}	Reverse Recovery Time	$I_F=1\text{A}, V_R=30\text{V}, di_F/dt=-200\text{A}/\mu\text{s}$	--	45	--	ns
t_{rr}	Reverse Recovery Time	$V_R=50\text{V}, I_F=100\text{A}$	--	90	--	ns
I_{RRM}	Max. Reverse Recovery Current		$di_F/dt=-200\text{A}/\mu\text{s}, T_J=25^{\circ}\text{C}$	--	8	--
t_{rr}	Reverse Recovery Time	$V_R=50\text{V}, I_F=100\text{A}$	--	150	--	ns
I_{RRM}	Max. Reverse Recovery Current		$di_F/dt=-200\text{A}/\mu\text{s}, T_J=125^{\circ}\text{C}$	--	16	--

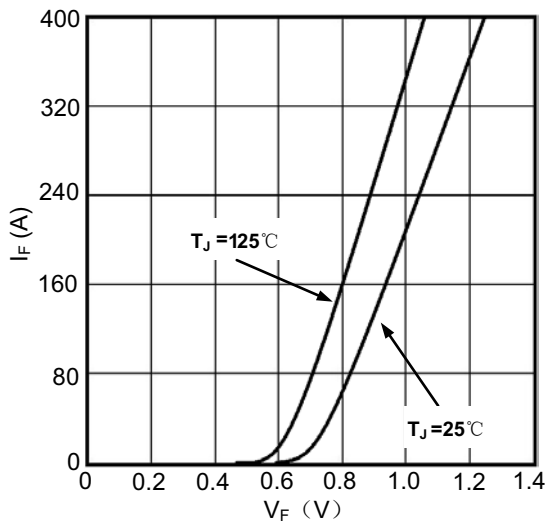

Figure1. Forward Voltage Drop vs Forward Current

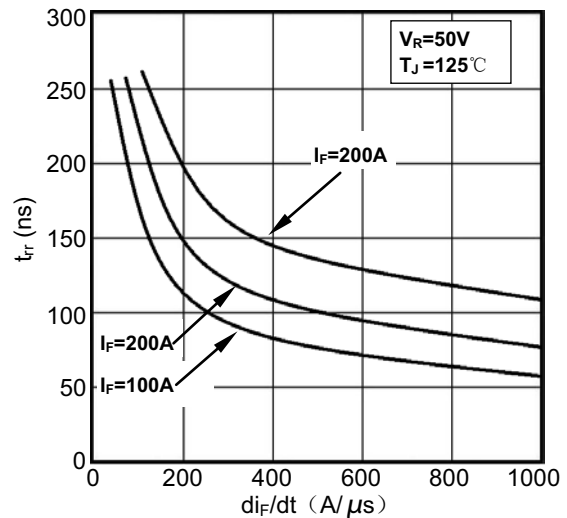

Figure2. Reverse Recovery Time vs di_F/dt

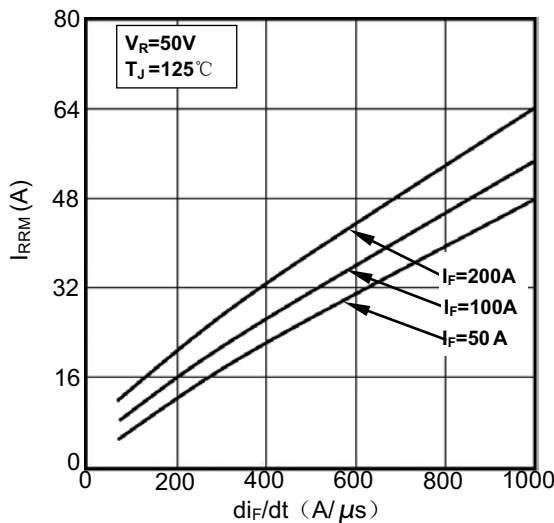

Figure3. Reverse Recovery Current vs di_F/dt

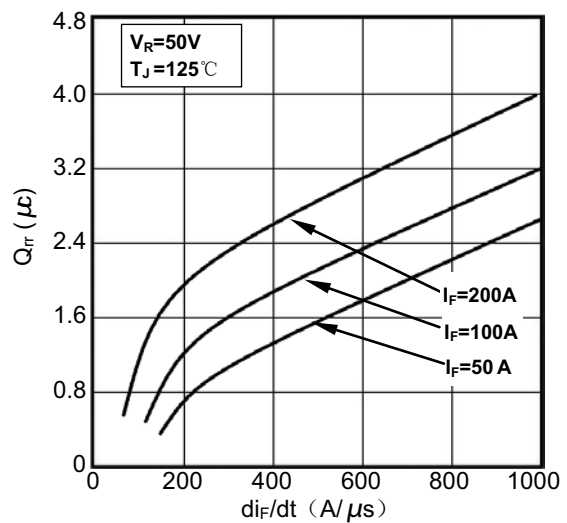

Figure4. Reverse Recovery Charge vs di_F/dt

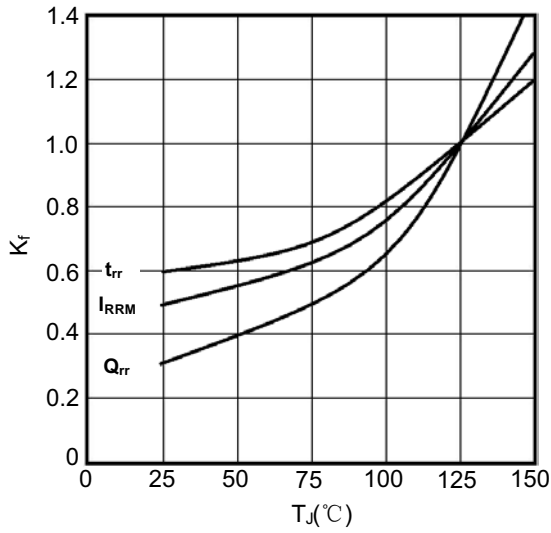

Figure5. Dynamic Parameters vs Junction Temperature

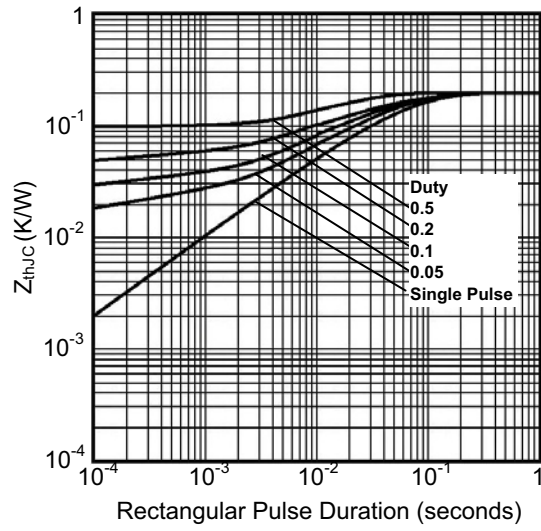
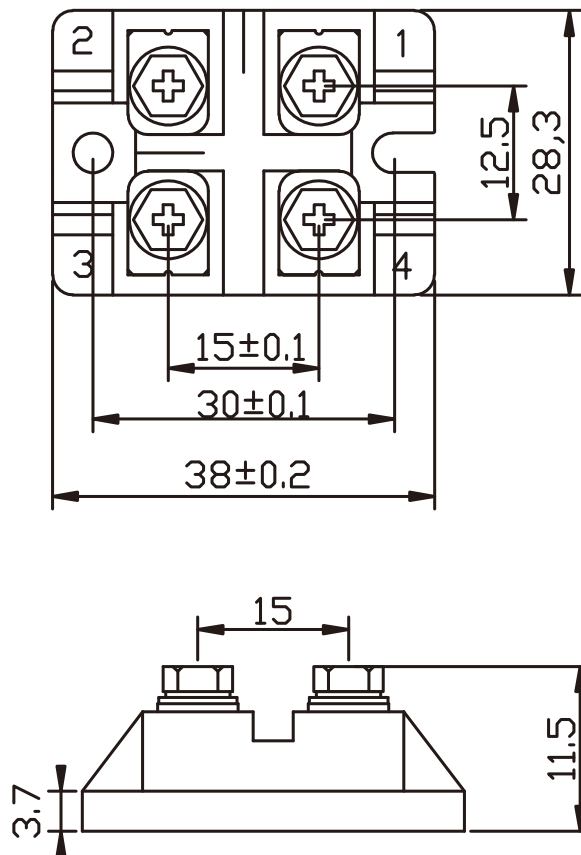

Figure6. Transient Thermal Impedance

Package Outline



Dimensions (mm)