

## 产品规格书

### Specifcation of products

产品名称: 三相整流桥

产品型号: MDS35A-H7

浙江世菱半导体有限公司  
ZHEJIANG SHILING SEMICONDUCTOR CO., LTD.

地址: 浙江省 丽水市 莲都区

电话: (0578) 3012571 3615078

传真: (0578) 3611180

邮编: 323000

E-mail: smrshiling01@163.com

Http://www.smrshiling.com

拟制	审核	核准
林益龙	曹剑龙	宗瑞

SYMBOL	CHARACTERISTIC	TEST CONDITIONS	T <sub>j</sub> (°C)	VALUE			UNIT
				Min	Type	Max	
I <sub>o</sub>	DC output current	Three-phase full wave rectifying circuit, T <sub>c</sub> =100°C	150		35		A
V <sub>RRM</sub>	Repetitive peak reverse voltage	V <sub>RRM</sub> tp=10ms V <sub>RSM</sub> = V <sub>DRM</sub> &V <sub>RRM</sub> +200V	150	600		1800	V
I <sub>RRM</sub>	Repetitive peak current	at V <sub>RRM</sub>	150			5	mA
I <sub>FSM</sub>	Surge forward current	10ms half sine wave V <sub>R</sub> =0.6V <sub>RRM</sub>	150			0.27	KA
I <sup>2</sup> t	I <sup>2</sup> T for fusing coordination					0.74	A <sup>2</sup> s*10 <sup>3</sup>
V <sub>FO</sub>	Threshold voltage		150			0.80	V
r <sub>F</sub>	Forward slop resistance					3.0	mΩ
V <sub>FM</sub>	Peak forward voltage	I <sub>FM</sub> =40A	25			1.20	V
R <sub>th(j-c)</sub>	Thermal resistance Junction to heatsink	Single side cooled				1.25	°C /W
V <sub>iso</sub>	Isolation voltage	50Hz,R.M.S,t=1min,I <sub>iso</sub> :1mA(max)		3000			V
F <sub>m</sub>	Terminal connection torque					---	N.m
	Mounting torque(M4)					3.0	N.m
T <sub>stg</sub>	Stored temperature			-40		150	°C
W <sub>t</sub>	Weight				72		g
Outline							

### OUTLINE DRAWING & CIRCUIT DIAGRAM

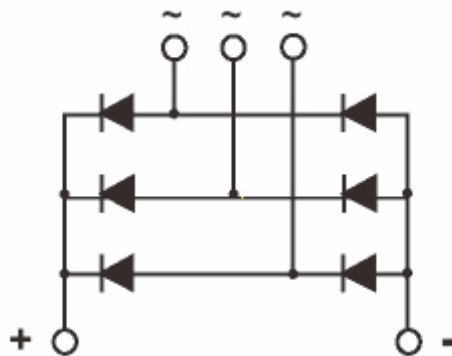

## Rating and Characteristic

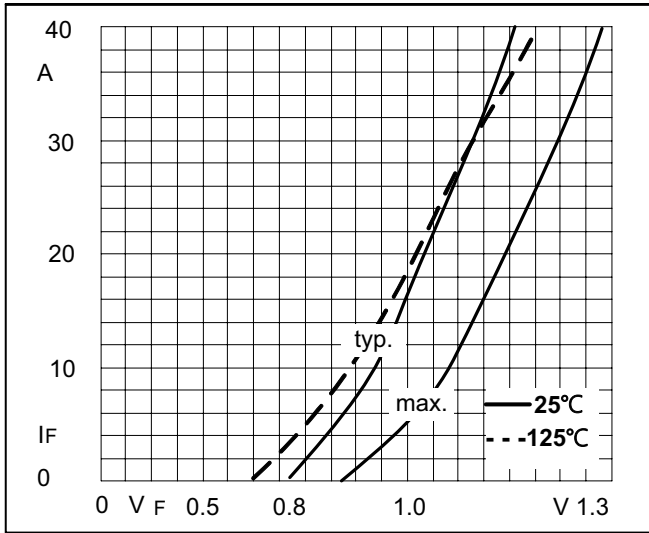

Fig1. Forward Characteristics

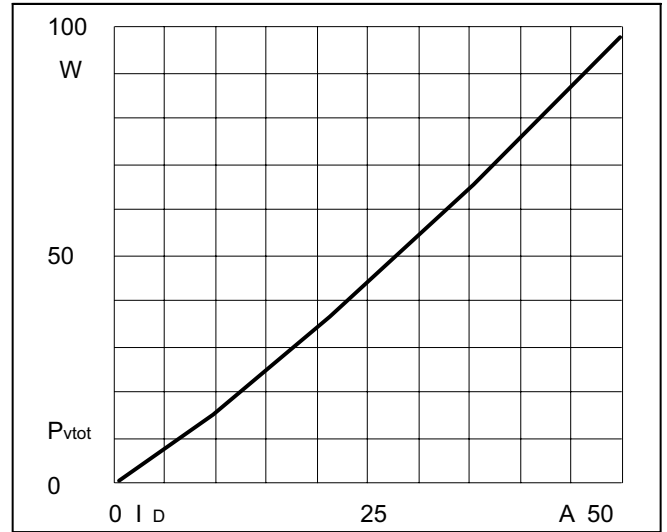

Fig2. Power dissipation

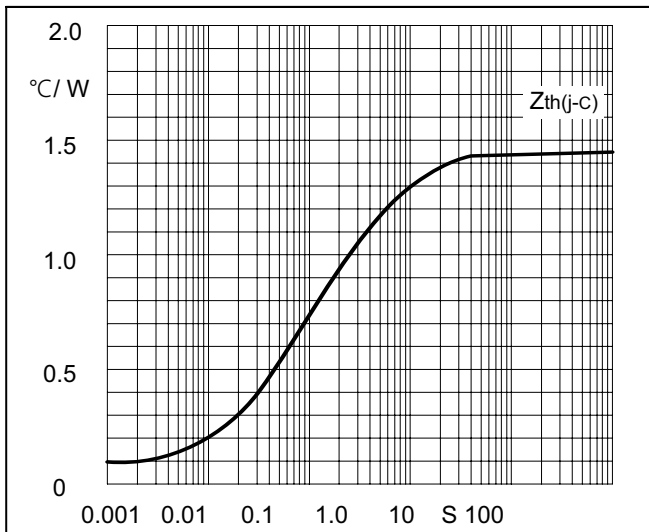

Fig3. Transient thermal impedance

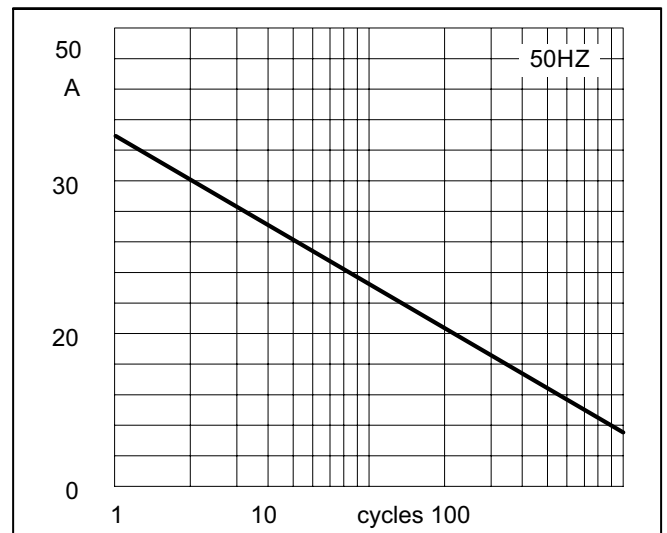

Fig4. Max Non-Repetitive Forward Surge Current

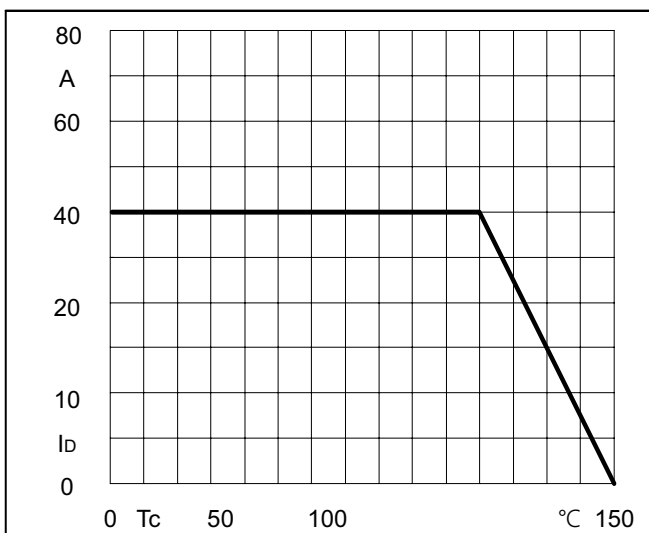
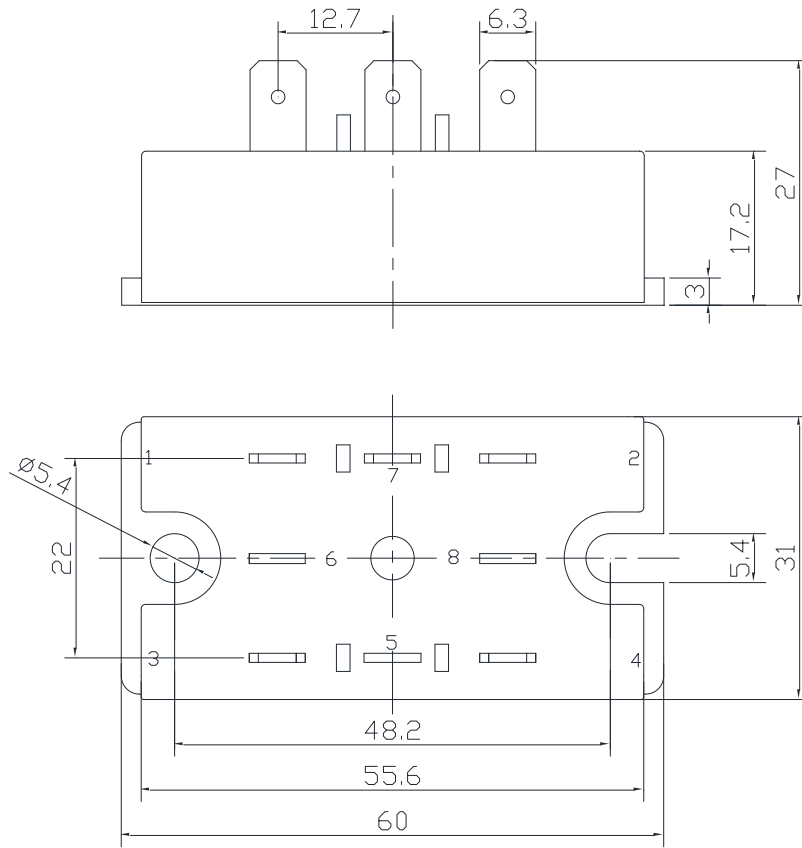

Fig5. Forward Current Derating Curve

## Package Outline Information



Dimensions in mm

