

产品规格书

Specifcation of products

产品名称:快速单相整流桥

产品型号:MFQ100U12N-H1

浙江世菱半导体有限公司
ZHEJIANG SHILING SEMICONDUCTOR CO., LTD.

地址:浙江省 丽水市 莲都区

电话:(0578) 3012571 3615078

传真:(0578) 3611180

邮编: 323000

E-mail:smrshiling01@163.com

Http://www.smrshiling.com

拟制	审核	核准
林益龙	曹剑龙	宗瑞

SYMBOL	CHARACTERISTIC	TEST CONDITIONS	T _j (°C)	VALUE			UNIT
				Min	Type	Max	
I _o	DC output current	Three-phase full wave rectifying circuit, T _c =100°C	150		100		A
V _{RRM}	Repetitive peak reverse voltage	V _{RRM} tp=10ms V _{RSM} = V _{DRM} &V _{RRM} +200V	150		1200		V
I _{RRM}	Repetitive peak current	at V _{RRM}	150			10	mA
I _{FSM}	Surge forward current	10ms half sine wave	150			0.92	KA
I ² t	I ² T for fusing coordination	V _R =0.6V _{RRM}				4.2	A ² s*10 ³
V _{FO}	Threshold voltage		150			0.80	V
r _F	Forward slop resistance					4.0	mΩ
V _{FM}	Peak forward voltage	I _{FM} =150A	25			2.3	V
t _{rr}	Reverse Recovery Time	I _F =1A, V _R =30V, di _F /dt=-200A/μs				55	ns
R _{th(j-c)}	Thermal resistance Junction to heatsink	Single side cooled				0.150	°C /W
V _{iso}	Isolation voltage	50Hz,R.M.S,t=1min,I _{iso} :1mA(max)		3000			V
F _m	Terminal connection torque(M5)				4.0		N.m
	Mounting torque(M6)				5.0		N.m
T _{stg}	Stored temperature			-40		125	°C
W _t	Weight				175		g
Outline							

OUTLINE DRAWING & CIRCUIT DIAGRAM

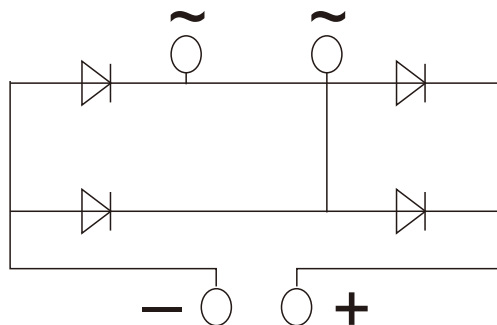

Rating and Characteristic

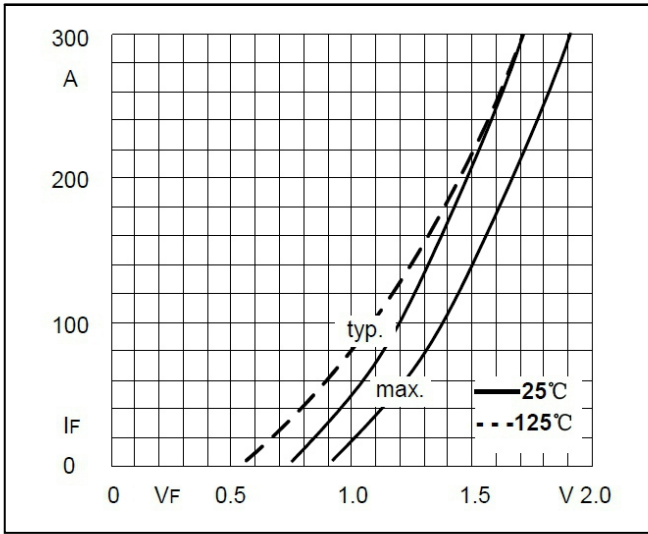

Fig1. Forward Characteristics

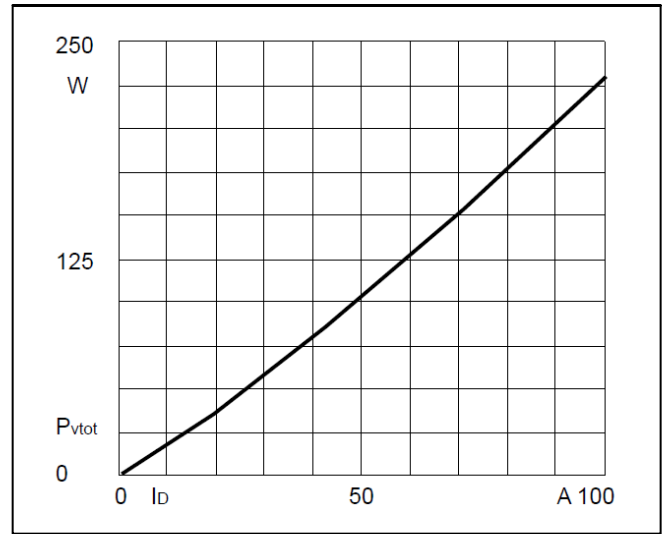

Fig2. Power dissipation

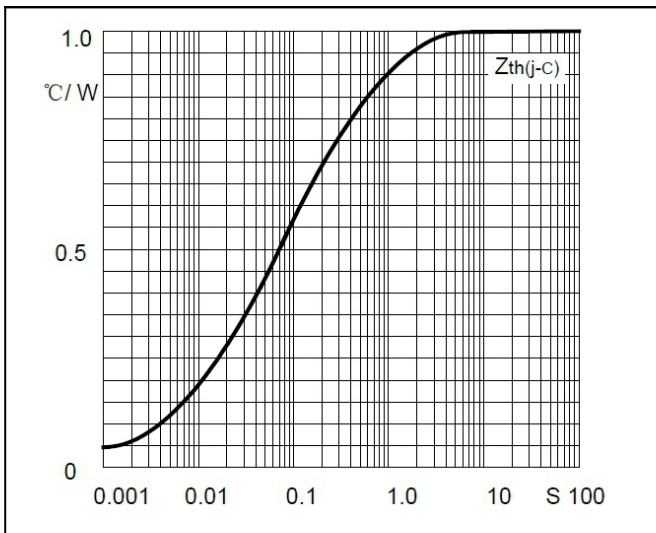

Fig3. Transient thermal impedance

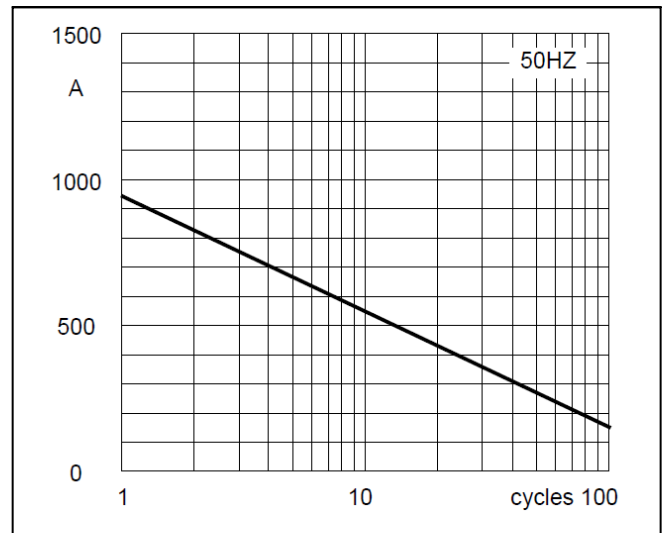

Fig4. Max Non-Repetitive Forward Surge Current

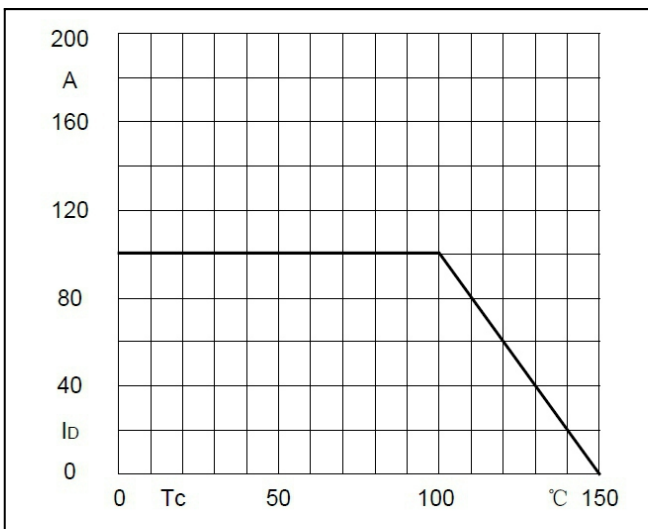
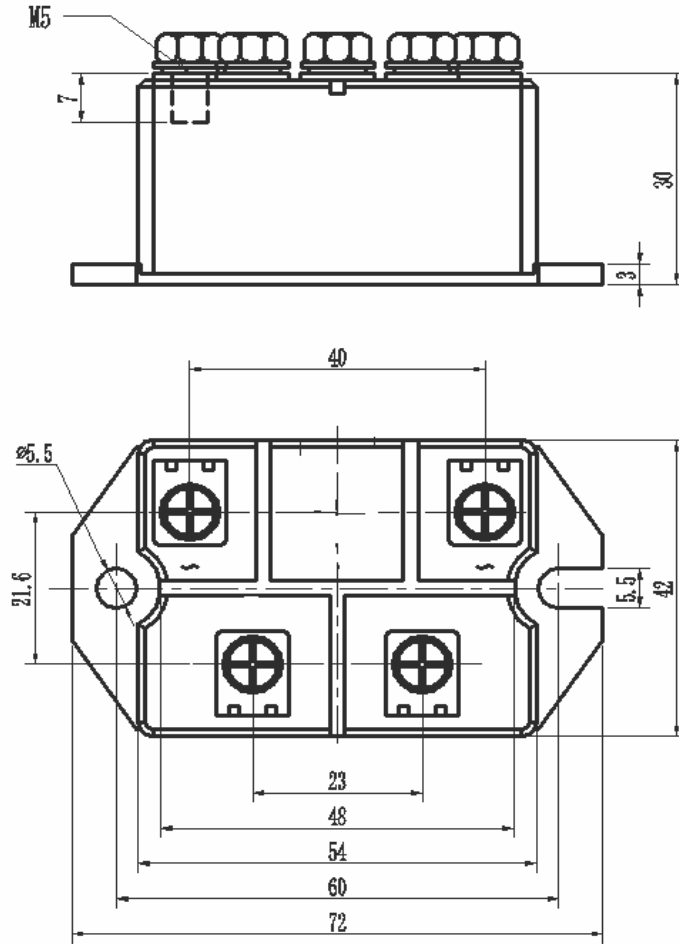

Fig5. Forward Current Derating Curve

Package Outline Information



Dimensions in mm

