

产品规格书

Specification of Products

产品名称：快恢复二极管

产品型号：MUK400100CT

浙江世菱半导体有限公司
ZHEJIANG SHILING SEMICONDUCTOR CO., LTD.

地址：浙江省 丽水市 莲都区

电话：(0578) 3012571 3615078

传真：(0578) 3611180

邮编：323000

E-mail: smrshiling01@163.com

Http://www.smrshiling.com

拟制	审核	核准
林益龙	曹剑龙	宗瑞

Ultra-Fast Soft Recovery Diode Module

Description

Ultra-FRD module devices are optimized to reduce losses and EMI/RFI in high frequency power conditioning electrical systems. These diode modules are ideally suited for power converters, motor drives and other applications where switching losses are significant portion of the total losses.

Features

- ☞ Repetitive Reverse Voltage $V_{RRM} = 100V$
- ☞ Low Forward Voltage Drop: $V_F(\text{typ.}) = 1.0V$
- ☞ Average Forward Current: $I_{F(AV)} = 400A$ @ $T_C = 100^\circ C$
- ☞ Ultra-Fast Reverse Recovery Time: $t_{rr}(\text{typ.}) = 95\text{ ns}$
- ☞ Extensive Characterization of Recovery Parameters
- ☞ Reduced EMI and RFI
- ☞ Non Isolation Type Package

Applications

Motor Drives, Free wheel use, High Power Converters, Welders, Various Switching and Telecommunication Power Supply

Equivalent Circuit and Package

Equivalent Circuit

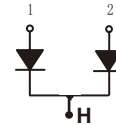

Package

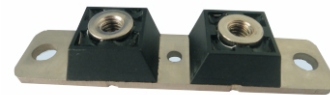

Please see the package Out line information

Absolute Maximum Ratings @ $T_J = 25^\circ C$ (Per Leg)

Symbol	Parameter	Conditions	Ratings	Unit
V_{RRM}	Repetitive Peak Reverse Voltage		100	V
$V_{R(DC)}$	Reverse DC Voltage		50	V
$I_{F(AV)}$	Average Forward Current	Resistive Load	800 400	A A
I_{FSM}	Surge (non-repetitive) Forward Current	One Half Cycle at 60Hz, Peak Value	8000	A
I^2_t	I^2t for Fusing	Value for One Cycle Current $t_W = 8.3ms, T_J = 25^\circ C$ Start	119×10^3	$A^2 s$
T_J	Junction Temperature		$-40 \sim 125$	$^\circ C$
T_{stg}	Storage Temperature		$-40 \sim 125$	$^\circ C$
P_d	Maximum Power Dissipation		1160	W
-	Mounting Torque		4.0	N.m
-	Terminal Torque		3.0	N.m

Thermal Characteristics

Symbol	Parameter	Conditions	Values			Unit
			Min.	Typ.	Max.	
$R_{th(j-c)}$	Thermal Resistance	Junction to Case	-	-	0.10	°C/W

Electrical Characteristics @ $T_j = 25^\circ\text{C}$ (unless otherwise specified)

Symbol	Parameter	Conditions	Values			Unit	
			Min.	Typ.	Max.		
V_R	Cathode Anode Breakdown Voltage	$I_R = 100\mu\text{A}$	100	-	-	V	
V_{FM}	Maximum Forward Voltage	$I_{FM} = 300\text{A}, T_c = 25^\circ\text{C}$	-	1.0	1.1	V	
		$I_{FM} = 300\text{A}, T_c = 100^\circ\text{C}$	-	0.7	0.8	V	
I_{RRM}	Repetitive Peak Reverse Current	$T_c = 100^\circ\text{C}, V_{RRM}$ applied	-	-	10.0	mA	
t_{rr}	Reverse Recovery Time	$I_{FM} = 300\text{A}, V_R = 150\text{V}, di/dt = -100\text{A}/\mu\text{s}$	$T_c = 25^\circ\text{C}$	-	95	100	ns
			$T_c = 100^\circ\text{C}$	-	180	-	ns

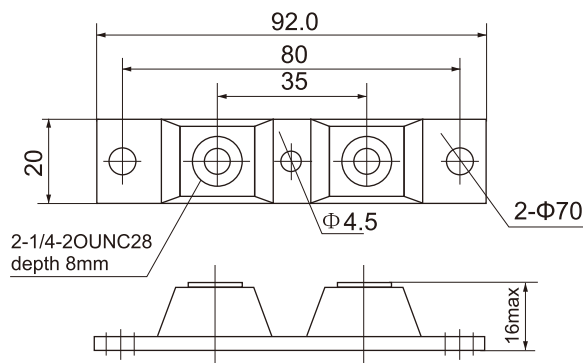

Performance Curves

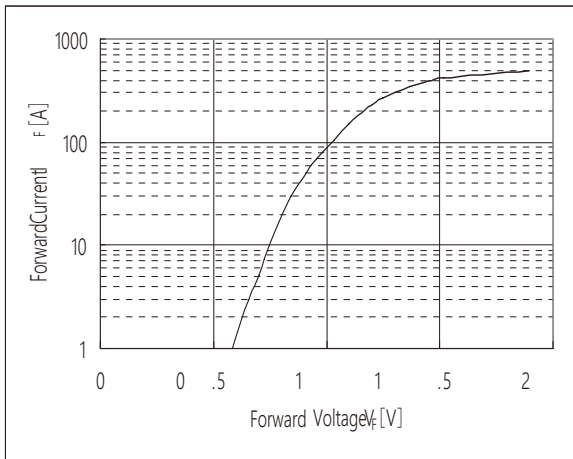

Fig. 1 : Typical Forward Voltage Drop vs. Instantaneous Forward Current

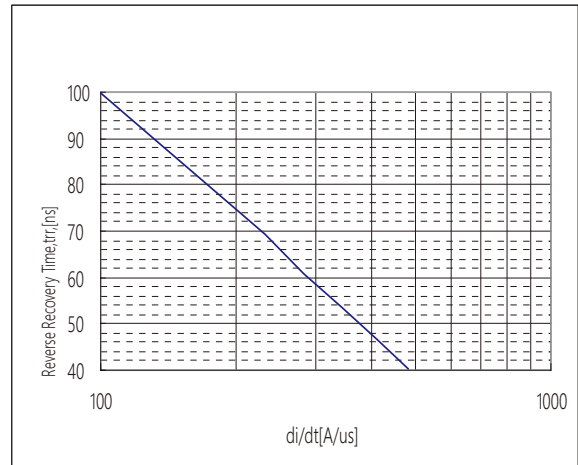

Fig. 2 : Typical Reverse Recovery Time vs. $-di/dt$

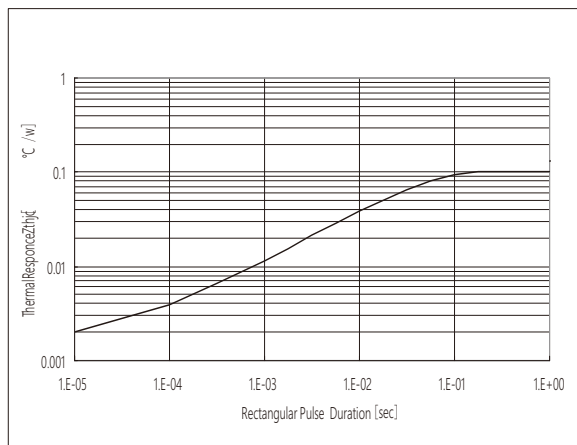

Fig. 3 : Transient Thermal Impedance ($Z_{th(j-c)}$) Characteristics

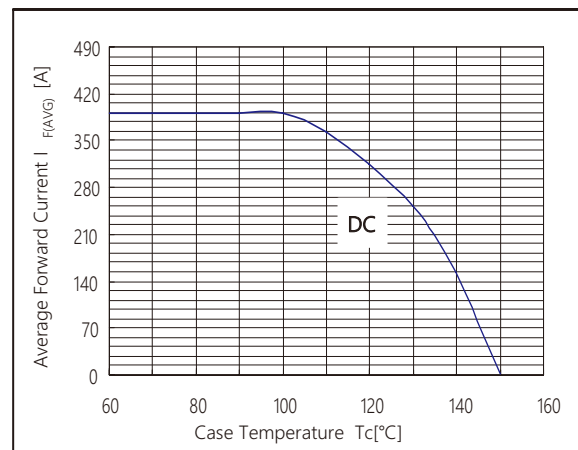

Fig. 4 : Forward Current Derating Curve